



215 EAST ROOSEVELT AVE.  
ZEELAND, MI 49464

## ODL / WESTERN REFLECTIONS SMART FRAME DOOR GLASS ASSEMBLY FOR GLAZING UP TO A 3'0 x 8'0 SINGLE PANEL "NON-IMPACT"

### GENERAL NOTES

- This product has been evaluated and is in compliance with the 7th Edition (2020) Florida Building Code (FBC) structural requirements excluding the High Velocity Hurricane Zone (HVHZ).
- When used in areas requiring wind borne debris protection this product is required to be protected with an impact resistant covering that complies with FBC Sections 1609.1.2 & R301.2.1.2.
- This product is approved for use as a substitute doorglass assembly in conjunction with a glazed fiberglass side hinged swing door and/or fixed sidelite possessing a comparable current Florida Statewide product approval.
- The design pressure (DP) rating shall be the lesser of the DP rating shown on Sheet 1 of this approval or the DP rating shown in the glazed fiberglass side hinged swing door or fixed sidelite approval being used.
- The door panel and lite opening size shall not exceed the sizes shown in this approval or the glazed fiberglass side hinged swing door or fixed sidelite approval being used.
- This product has been tested in the door and/or sidelite panels as specified on Sheet 3 of this approval. Substitution into a similar product may be approved for use by the local Authority Having Jurisdiction. In all cases, the glazed fiberglass door and/or sidelite used must possess a comparable current Florida Statewide product approval.

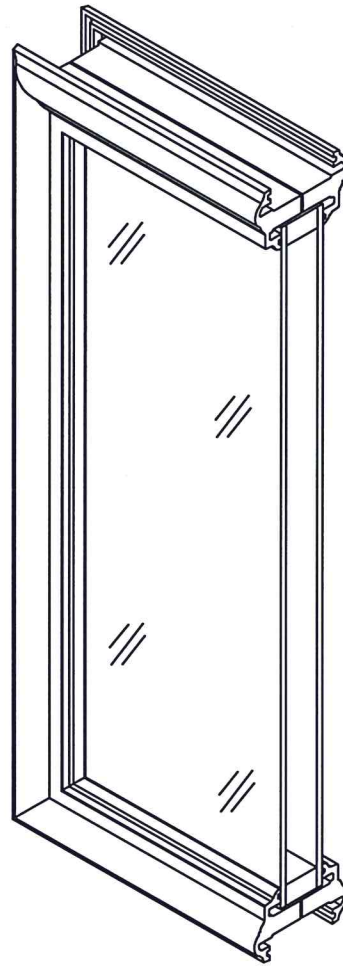

SMART FRAME DOORGLASS ASSEMBLY

SMART FRAME DESIGN PRESSURE RATING (PSF)		
GLAZING TYPE	POSITIVE	NEGATIVE
1" INSUL.	+60.0	-60.0

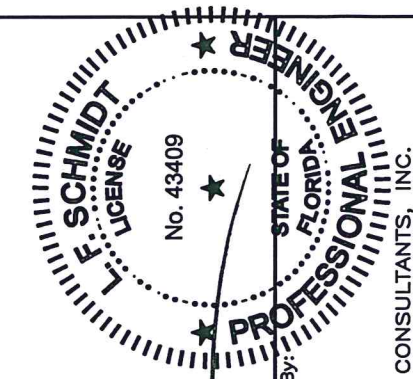
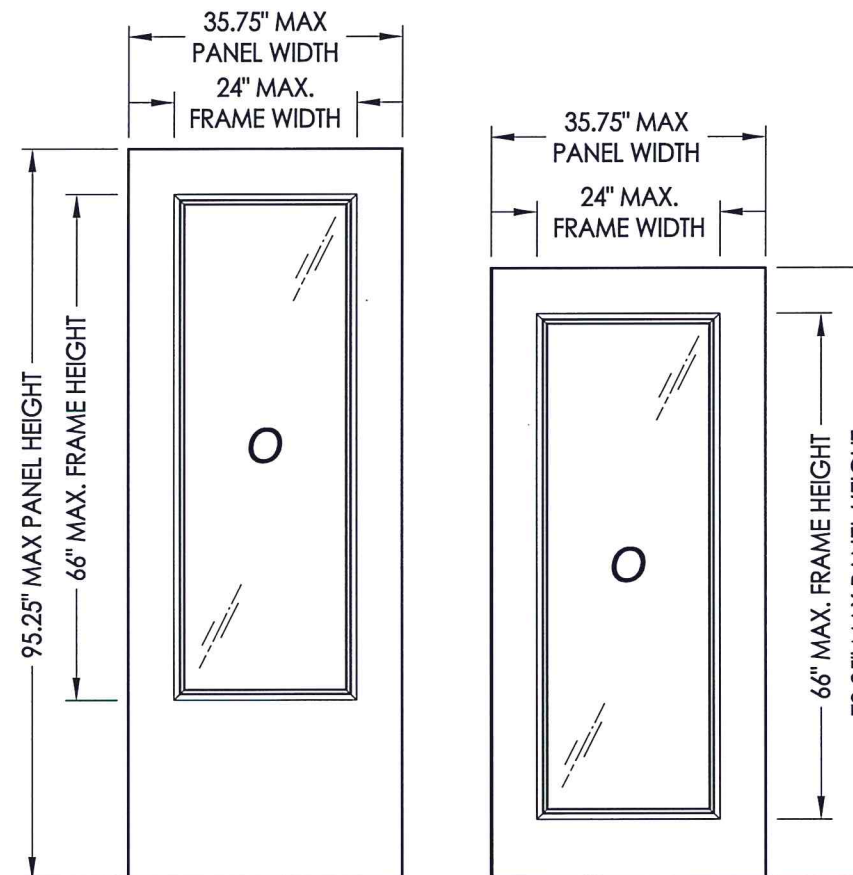

August 07, 2020  
 Documents Prepared By:  
 Lyndon F. Schmidt  
 P.E. No. 43409

**R.W.** BUILDING CONSULTANTS, INC.  
 P.O. Box 230, Valrico, FL 33595  
 Phone No.: 813.659.9197  
 FBPE Registry No. 9813

PRODUCT: SMART FRAME	PART OR ASSEMBLY: TYPICAL ELEVATIONS, DESIGN PRESSURES & GENERAL NOTES
NO.    DATE	REVISIONS
4    8/05/20    UPDATE TO 7TH ED. (2020) FBC	DAC
3    9/27/18    REMOVED TRADITIONAL FRAME	LFS
2    9/26/17    UPDATE TO 6TH ED. (2017) FBC	JK
1    3/28/15    UPDATE TO 5TH ED. (2014) FBC	JK
DATE: 2/29/12	
SCALE: N.T.S.	
DWG. BY: JK	
CHK. BY: LFS	
DRAWING NO.: FL-15260.5	
SHEET 1 OF 3	

TABLE OF CONTENTS	
SHEET #	DESCRIPTION
1	Typical elevations, design pressures and general notes
2	Cross sections and glazing details
3	Fiberglass door panels

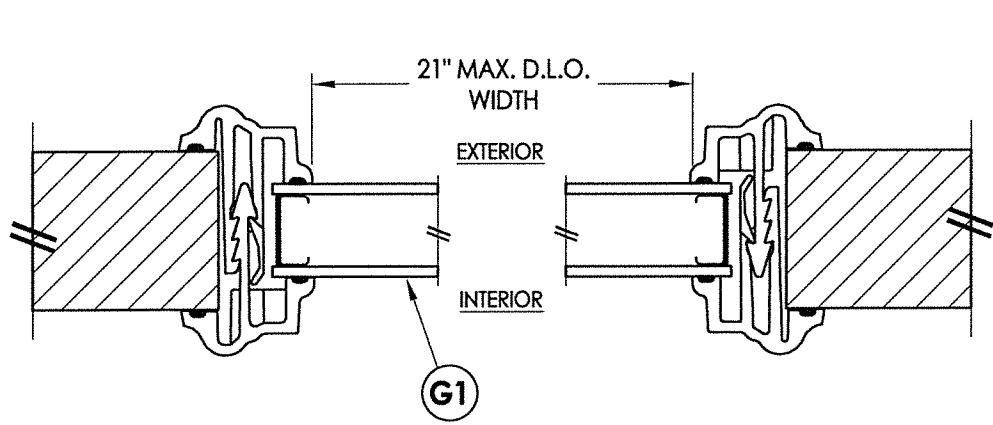

2  
2 HORIZONTAL CROSS SECTION

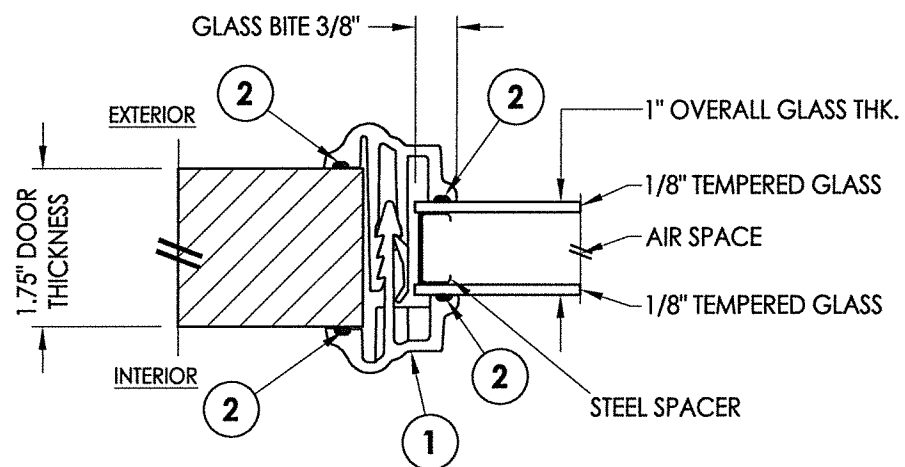

G1 GLAZING DETAIL

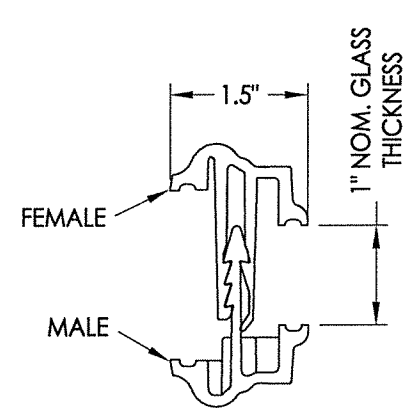

ODL SMART FRAME  
HP POLYPROPYLENE

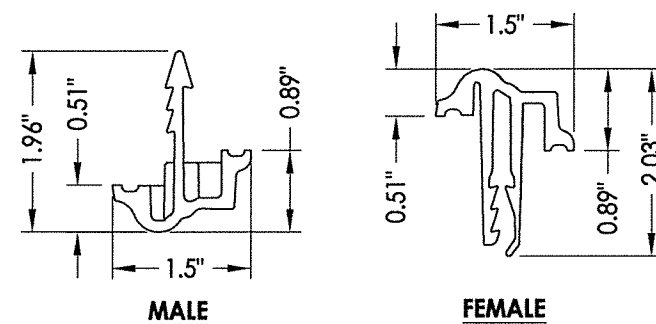

1 SMART FRAME

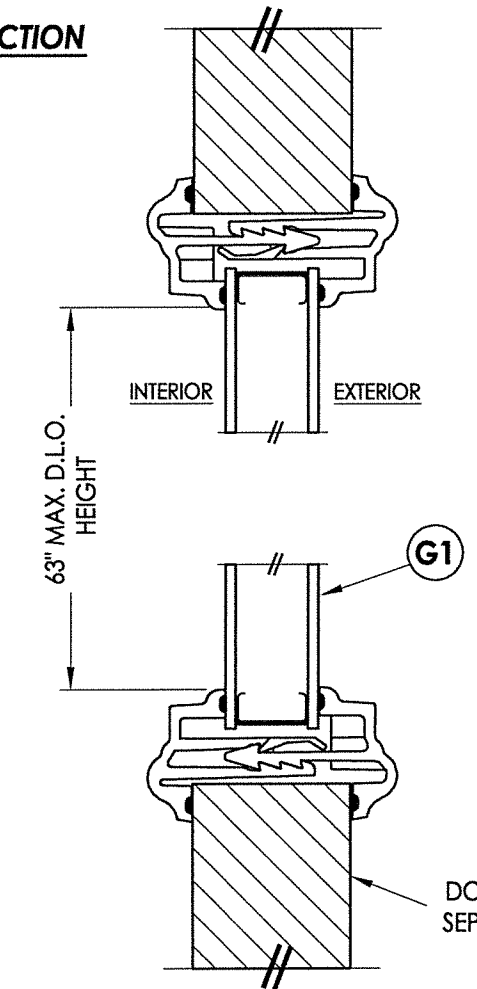
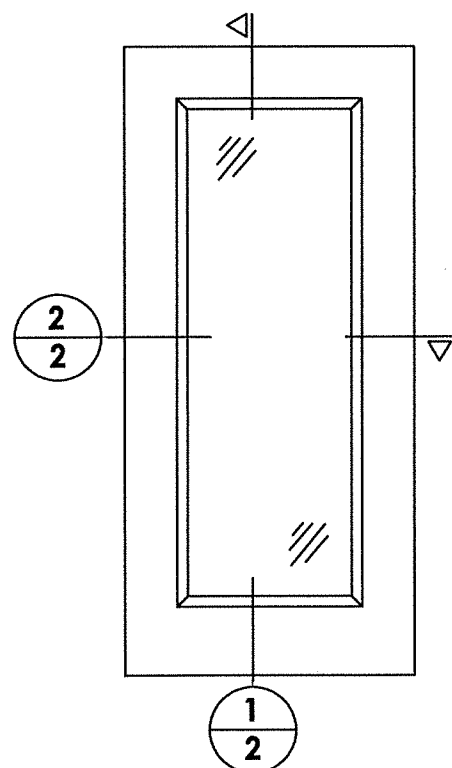

1  
2 VERTICAL CROSS SECTION

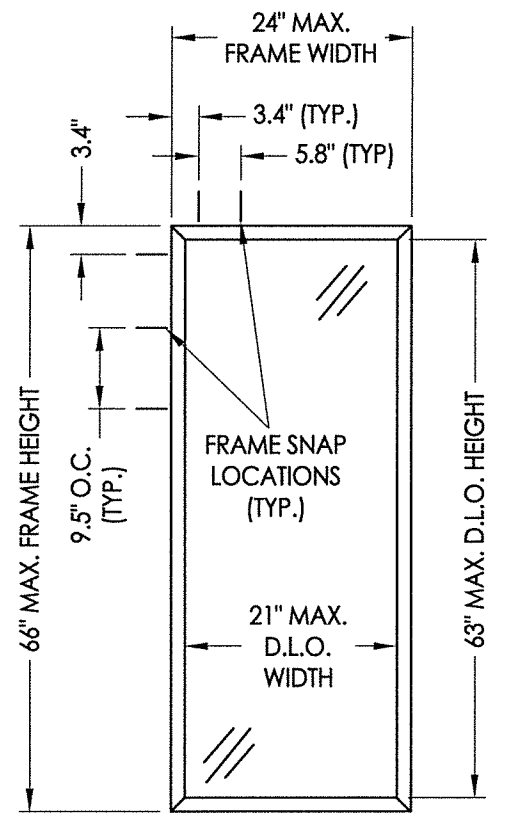

24" x 66" SMART FRAME DOORGLASS

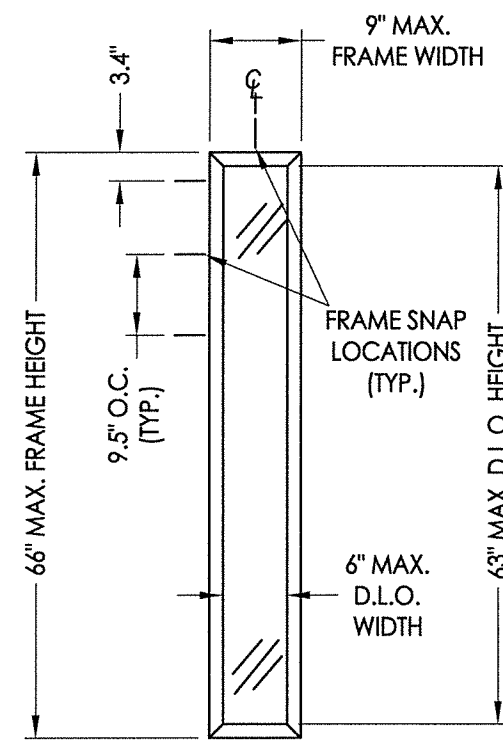

9" x 66" SMART FRAME DOORGLASS

BILL OF MATERIALS		
ITEM #	DESCRIPTION	MATERIAL
1	ODL SMART FRAME	HP POLYPRO
2	FOAM-IN-PLACE GASKET	URETHANE

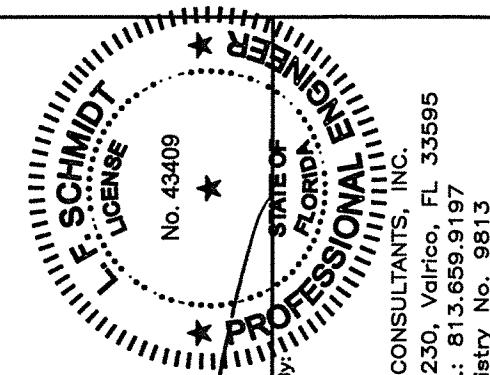

August 07, 2020

Documents Prepared By:  
Lyndon F. Schmidt  
P.E. No. 43409

RW BUILDING CONSULTANTS, INC.  
P.O. Box 230, Valrico, FL 33595  
Phone No.: 813.659.9197  
FBPE Registry No. 9813

PRODUCT: SMART FRAME  
PART OR ASSEMBLY: CROSS SECTIONS & GLAZING DETAILS

NO.	DATE	REVISIONS
4	8/05/20	UPDATE TO 7TH ED. (2020) FBC
3	9/27/18	REMOVED TRADITIONAL FRAME
2	9/26/17	UPDATE TO 6TH ED. (2017) FBC
1	3/28/15	UPDATE TO 5TH ED. (2014) FBC

DATE: 2/29/12  
SCALE: N.T.S.  
DWG. BY: JK  
CHK. BY: LFS  
DRAWING NO.: FL-15260.5  
SHEET 2 OF 3

\\dc01\wbc\Clients\ODL, Inc. PERMANENTA - Florida Product Approvals\FL-15260 Exterior Door Components - Lite Frame Inserts\C - Drawings\FL 15260 (2020) R9\FL-15260.5.dwg

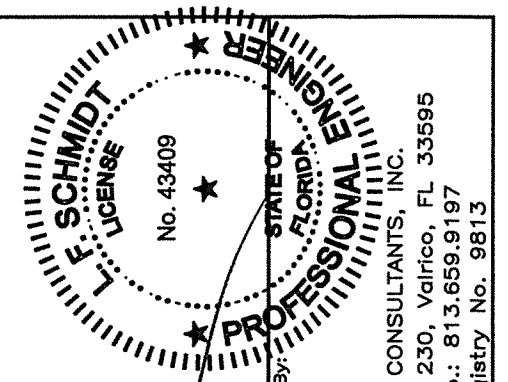
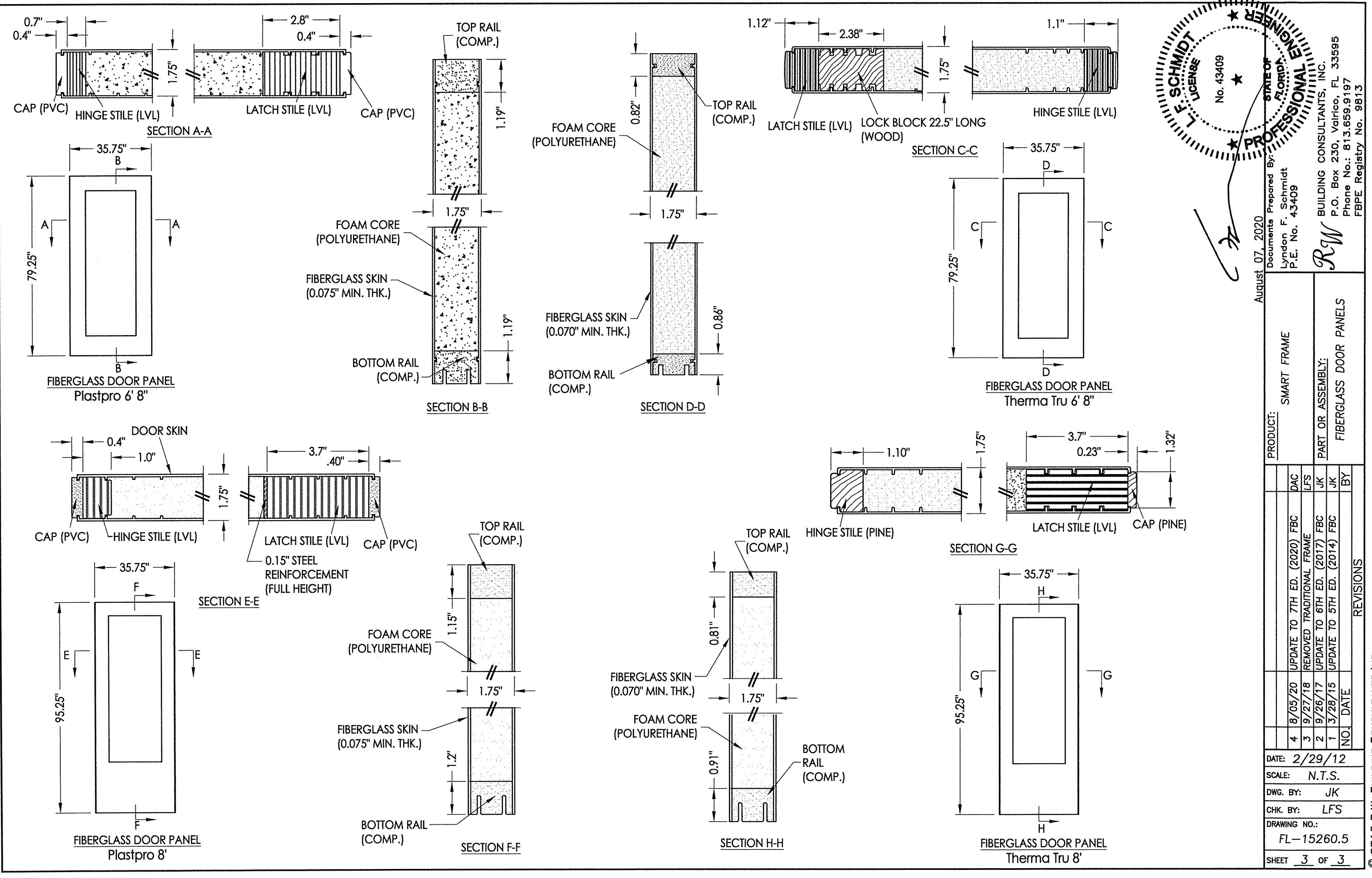

August 07, 2020  
 Documents Prepared By:  
 Lyndon F. Schmidt  
 P.E. No. 43409

PRODUCT:	SMART FRAME
PART OR ASSEMBLY:	FIBERGLASS DOOR PANELS

NO.	DATE	BY
4	8/05/20	DAC
3	9/27/18	LFS
2	9/26/17	JK
1	3/28/15	JK

DATE:	2/29/12
SCALE:	N.T.S.
DWG. BY:	JK
CHK. BY:	LFS
DRAWING NO.:	FL-15260.5
SHEET	3 of 3